

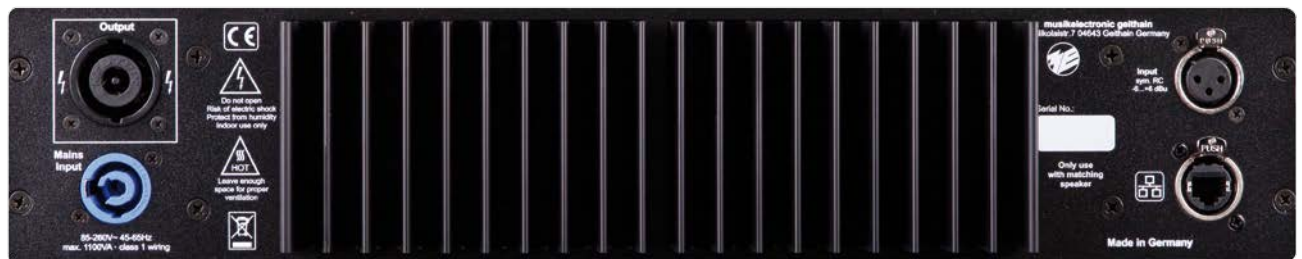

musikelectronic geithain RL-Amplifier



Instructions for installation and use

Table of contents

1	Introduction	1
2	Disclaimer	2
3	System description	3
4	Specifications	4
4.1	Technical specifications	4
5	Basic information	5
5.1	Guidelines	5
5.2	Disposal	5
5.3	Safety instructions	7
5.4	Unboxing	10
5.5	Delivery contents	10
5.6	Environmental conditions	10
5.7	Guarantee acknowledgements	10
6	Controls and connections	11
6.1	Front	11
6.2	Back	11
7	Installation and operation	12
7.1	Mounting	12
7.2	Wiring	12
7.3	Cable connection	13
8	Operation and configuration of the device	14
8.1	Desktop software ME Geithain DSP Control	14
8.2	Menu structure	14
8.3	Home screen	14
8.4	Preset menu	15
8.5	Channel menu	16
8.6	Entering names and passwords	18
9	User rights	19
10	Troubleshooting	20
11	Notes	21

1 Introduction

Dear customer,

Thank you for the trust you have put in us by buying these speakers. You decided upon a quality product that in regard to tonal and technical characteristics complies to the utmost expectations.

The usual burn-in period is not required, because the speakers are artificially aged in-house.

Please read the technical description and manual to take advantage of the capabilities of these speakers and ensure safe operation.

2 Disclaimer

Technical data and appearances are subject to changes without notice. Errors and omissions excepted. Musikelectronic Geithain GmbH assumes no liability for any loss which may be suffered by any person who relies either wholly or in part upon any description, photograph or statement contained herein. Musikelectronic Geithain GmbH products are sold through authorized fulfillers and resellers only. Fulfillers and resellers are not agents of Musikelectronic Geithain GmbH and have absolutely no authority to bind Musikelectronic Geithain GmbH by any express or implied undertaking or representation. This manual is copyrighted. No part of this manual may be reproduced or transmitted in any form or by any means, electronic or mechanical, including photocopying and recording, or by any information storage or retrieval system without the prior written permission of Musikelectronic Geithain GmbH.

All rights reserved

Copyright © 2020 Musikelectronic Geithain GmbH

3 System description

The RL-Amplifier is a device especially designed as a separate 19 inch rack amplifier for all three-way studio monitors from Musikelectronic Geithain GmbH. The amplifier has PWM power amplifiers to allow operation with convection cooling in a compact 19 inch housing. It offers technical protective measures to ensure safe operation of the attached loudspeaker.

4 Specifications

4.1 Technical specifications

Mains voltage	85 V ... 260 V
Power consumption	
Maximum	1100 W
No-load	35 W
Stand-by	18 W
Mains connector	1 × Powercon
Maximum output power limited to	
LF	650 W (Loudspeaker dependent limiting)
MF	200 W (Loudspeaker dependent limiting)
HF	200 W (Loudspeaker dependent limiting)
Noise level	≤ 7 dB(A) / r = 1 m (3'3")
Inputs	1 × XLR analogue optionally 1 × XLR AES / EBU
Nominal input level	+6 dBu
Maximum input level	+22 dBu
Outputs	1 × Neutrik Speakon NL8 MPR
Control inputs	1 × RJ45 Ethernet 1 × USB
Operation indicator at RL-Amplifier	Display blue
Level indicator	Green LED band at amplifier Overdrive red
Equalizer	10 free programmable parametric EQs
Delay	up to 1,000 ms
Dimensions (h × w × d)	440 (front panel 485) × 290 × 90 mm (2 HE) [17.3" (front panel 19.1 ") × 11.4" × 3.5"]
Weight	7.3 kg (16.1 lbs)
Environmental specifications	
Operating temperature	+15 °C ... +35 °C (+59 °F ... +95 °F)
Storage temperature	-25 °C ... +45 °C (-13 °F ... +113 °F)
Relative humidity	45 % ... 75 %

5 Basic information

5.1 Guidelines

This product complies to requirements of current European and national guidelines. The conformity is ascertained, corresponding declarations and records are deposited with the manufacturer.

EC Declaration of Conformity in accordance to EC Directives

- ◀ Electromagnetic Compatibility (2004/108/EG)
- ◀ Low Voltage Directive (2006/95/EG)

This product conforms to the following standards:

- ◀ EN55103-1 Emission
- ◀ EN55103-2 Immunity

5.2 Disposal

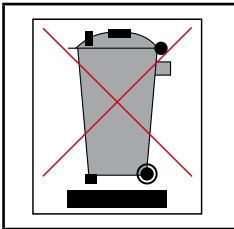

Products built by us belong to B2C-class of the WEEE guidelines and must not be disposed with domestic waste.

5.2.1 Germany

It is not allowed to dispose of used electrical equipment as domestic waste.

Non-reusable parts of the mounting accessories have to be disposed according to national environmental regulations.

Ensure disposal of damaged mounting accessories before they could be reused.

But do not dispose these products and accessories at official collecting points for recycling either!

Disposal of Musikelectronic Geithain GmbH products labelled with a waste bin sign have thus to be disposed of by Musikelectronic Geithain GmbH alone. Please call Musikelectronic Geithain GmbH at the number stated below if you have a Musikelectronic Geithain GmbH product to be disposed. We will offer you a straightforward and professional disposal not affecting cost.

If there is no waste bin sign on one of your Musikelectronic Geithain GmbH products, because they have been sold before March 2006 then by law the owner is in charge of the disposal. For these we will be happy to assist and offer you proper ways of disposal.

Declaration: With the ElektroG (law relating to electrical and electronic equipment and appliances) we have complied with the EU-directive on waste electrical and electronic equipment (WEEE, 2002/96/EC).

The Musikelectronic Geithain GmbH has thus labelled all products mentioned in the WEEE from 03/24/2006 onwards with a sign with a crossed out waste bin and a white bar below. This sign indicates that the disposal into the domestic waste is prohibited and that the product has been put into circulation at the 03/24/2006 earliest.

The Musikelectronic Geithain GmbH has been legally registered as a manufacturer with the registration office EAR. Our WEEE registration No. is: DE 72 4045 19

5.2.2 EU, Norway, Iceland and Liechtenstein

It is not allowed to dispose of used electrical equipment as domestic waste.

The Musikelectronic Geithain GmbH has thus labelled all products coming from EU-Member countries as well as Norway, Iceland and Liechtenstein (except Germany) mentioned in the WEE from 08/13/2005 onwards with a sign with a crossed out waste bin and a white bar below. This sign indicates that the disposal into the domestic waste is prohibited and that the product has been put into circulation at the 08/13/2005 earliest.

Unfortunately the European directive WEEE has been complied with implementing different national provisions of law throughout all member countries, which makes it impossible for us to offer consistent solutions for the disposal throughout Europe.

Responsible for complying with these provisions of law is the local distributor (importer) of each country.

For proper disposition of used products in accordance with these local provisions in the mentioned countries of the European Union (except Germany) please ask your local dealer or the local authorities.

5.2.3 Other countries

For proper disposition of used products in accordance with these local provisions in other countries please ask your local dealer or the local authorities.

5.3 Safety instructions

Like using any other electrical device you should observe the following operation guidelines, safety instructions and warning signs to ensure optimum functionality and safety of operation!

- ◀ Read these instructions carefully.
- ◀ Keep these instructions during the life cycle at a safe place. The instructions are an important part of the product.
- ◀ Heed all warnings. Follow all instructions.
- ◀ The product may only be used in accordance with the information provided in the user manual. Before and during the usage of the amplifier please ensure that all recommendations, especially the safety recommendations in the user manual, are adhered to.
- ◀ Do not place this product on an unstable cart, stand, tripod, bracket, or table. The product may fall, causing serious injury, and damage to the product.
- ◀ The heat sink must not be blocked or covered. This product should not be installed unless proper ventilation is provided or manufacturer's instructions have been adhered to.
- ◀ Do not install the device near any heat sources.
- ◀ Do not expose the device to direct sun radiation.
- ◀ Do not try to insert anything into device openings.
- ◀ Do not install the device in rooms with high humidity.
- ◀ The device shall not be exposed to dripping or splashing and no objects filled with liquids shall be placed on the device.
- ◀ Clean only with dry or slightly moistened cloth.
- ◀ Protect the power cord from being walked on, pinched or damaged in any other way. Pay particular attention to plugs and the point where they exit the device.
- ◀ Do not attempt to service this product yourself as opening or removing cover may expose you to dangerous voltage or other hazards.
- ◀ There is risk of electric shock when the device is open.
- ◀ Refer all servicing to qualified service personnel.

Water, rain, humidity and dust

The device is not protected against water, rain or excessive humidity and mustn't be exposed to these environmental conditions or operated next to them. Employ appropriate safety measures to prevent dust and dirt to get into the device. Dust and humidity are often the main reason for high voltage creepage paths and serious electrical dangers.

Maintenance

Unplug the device from the mains supply and refer to your authorised retailer or authorised repair and maintenance shop or the manufacturer. Maintenance is only allowed by one of the stated groups, because opening or removing the cover could expose you to dangerous voltages or other dangers. Maintenance is required when ...

- ◀ ... liquid has been spilled or objects have fallen into the device,
- ◀ ... the device has been exposed to rain or moisture,
- ◀ ... the device has been dropped or suffered damage in any other way,
- ◀ ... the device exhibits a distinct change from its normal function or performance.

Repair and replacement parts

All service and repair work must be carried out by an authorised retailer or an authorised repair and maintenance shop or the manufacturer. When replacement parts are required, please ensure that only replacement parts specified by the manufacturer are used. The use of unauthorized replacement parts may result in injury and/or damage through fire or electric shock or other electricity-related hazards.

Transport

To ship this device, always use the original shipping carton and packaging materials. For best protection pack it the same way as the manufacturer.

Environments

Use this product only in E1, E2, E3 or E4 environments according to EN55103-2 "Electromagnetic compatibility – Product family standard for audio, video and audio-visual and entertainment lighting control apparatus for professional use – Part 2: Immunity".

Air vents and heat sink

The air vents and the heat sink are provided to ensure reliable operation of the device and to protect it from overheating. The air vents and the heat sink must not be blocked or covered. This device should not be installed unless proper ventilation is provided or manufacturer's instructions have been adhered to.

Cleaning

Unplug the device from the wall outlet before cleaning. Do not use liquid or aerosol cleaners.

Power-cord protection

Power supply cords should be routed so that they are not likely to be walked on or pinched by items placed upon them or against them, paying particular attention to cords and plugs, and the point where they exit from the device.

Lightning

For added protection of the product during lightning storms, or when it is left unattended and unused for long periods of time, unplug it from the wall outlet. This will prevent damage to the product due to lightning and power-line surges.

Interference of external objects and/or liquids with the appliance

Never push objects of any kind into this product through openings as they may touch dangerous voltage points or short out parts that could result in a fire or electric shock. Never spill liquid of any kind on the device.

Connecting

When you connect the device to other equipment, turn off the power and unplug all of the equipment from the supply source. Failure to do so may cause an electric shock and serious personal injury. Read the user's manual of the other equipment carefully and follow the instructions when making the connections.

Sound level

Reduce the level to minimum before you turn on the speaker to prevent sudden high levels of noise which may cause hearing or speaker damage.

Power failure

In case of power failure while the amplifier is powered up, it will automatically restart as soon as the mains supply is restored. All settings made before the power failure are restored.

Speakon connectors and Speakon cords

To prevent electric shock, do not operate the product with any of the conductor portion of the speaker wire exposed.

Employ appropriate safety measures when connecting the power cord. When installing or connecting the product, disconnect it from mains supply. The product mustn't be connected to other alternating voltages and sockets than demanded on the back of the device.

IMPORTANT: Only off-the-shelf cables are allowed to be used to connect the product to mains.

IMPORTANT: To disconnect the product from mains, first disconnect the power cord from the socket, and then remove the cable from the product.

THE MAINS CONNECTION MUSTN'T BE DISCONNECTED FROM PROTECTIVE EARTH. THAT'S ILLEGAL AND DANGEROUS!

5.4 Unboxing

The speakers are shipped in proper condition. Unpack the speaker carefully and check for visible damages. In case of damages report them to your retailer. Keep the packaging, in case the speaker has to be transported in the future.

To unpack the device please refer to the additional user manual for unboxing.

5.5 Delivery contents

- ◀ Amplifier
- ◀ Powercon cable
- ◀ shielded Speakon cable (NL8)
- ◀ Technical description and user manual

5.6 Environmental conditions

Ensure the following environmental conditions in your listening room:

- ◀ Operating temperature +15 °C ... +35 °C (+59 °F ... +95 °F)
- ◀ Storage temperature range -25 °C ... +45 °C (-13 °F ... +113 °F)
- ◀ Relative humidity 45 % ... 75 %

5.7 Guarantee acknowledgements

Opening the device by unauthorized personnel leads to all claims under guarantee expire. In case of destruction by overload, misuse or outside influences there are no claims under guarantee.

6 Controls and connections

6.1 Front

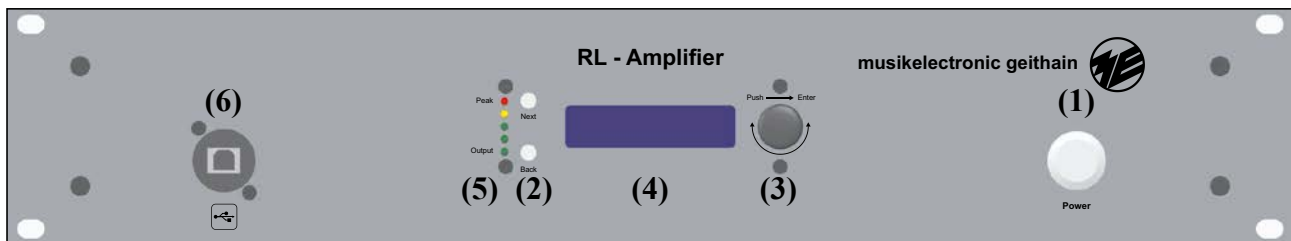

- ◀ Power button to switch the device on and off **(1)**
- ◀ NEXT and BACK buttons control the device and are used to navigate the menu and to set parameters (see chapter "8 Operation and configuration of the device", page 14) **(2)**
- ◀ Rotary encoder controls the device and is used to navigate the menu and to set parameters (see chapter "8 Operation and configuration of the device", page 14) **(3)**
- ◀ A 2x20 digit display shows user interactions and status. During action it could be dimmed or even shut down **(4)**
- ◀ LED-level indicator in case of limiting or clipping **(5)**
- ◀ USB port type B is used to configure the device with the software ME Geithain DSP Control **(6)**

6.2 Back

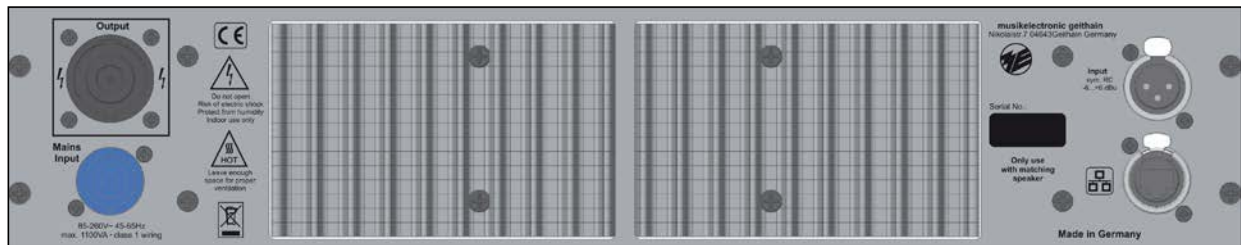

- ◀ Mains supply with Powercon **(7)**
- ◀ 8 pin speakon connector for connection with a loudspeaker **(8)**
- ◀ LINE In XLR3 F symmetrical connector for input signals **(9)**
- ◀ Ethernet port 10/100 Mbit/s RJ45 as a configuration interface for remote access with ME Geithain DSP Control through a standard TCP/IP network **(10)**

7 Installation and operation

Every amplifier is paired to exactly one speaker by the same serial number. The according serial number is located next to the input. Ensure installation in pairs.

7.1 Mounting

During installation ensure sufficient convection at the heat sink. The amplifier should not be installed below devices that tower above it.

In case of rack installation the amplifier is only screwed to the rack through the face plate. Therefore ensure secure mounting.

7.2 Wiring

- ◀ Turn off all equipment and ensure the speakers are not connected to mains supply.
- ◀ Use only cables complying with national security regulations. Before use, inspect the cables for obvious damages (e.g. through bends).
- ◀ Switch on peripheral devices (mixing consoles, effects, etc.) first, amplifiers and speakers should be the last devices to be switched on. Stick to this order, otherwise switching noises could damage the systems.
- ◀ In case of noise, turn off all devices in reverse order and check all cable connections. After that switch on the other peripheral devices and check them for interferences.
- ◀ For long-term installations a permanent connection to the network is advisable, to ease the maintenance respective configuration capabilities of the amplifier.
- ◀ Ensure all cables are installed in a way that nobody can trip over them.

Before start-up check the mains voltage stated on the back of the device. If your local mains voltage does not match the specification of the amplifier, please refer to your retailer or direct distribution. When the stated and your local mains voltage comply connect the mains connector **(7)** to the socket with the included mains cable.

For further connections, ensure the amplifier is turned off. In case the device is in operation, turn off the device by pressing the power button at the front of the device **(1)**. Now connect the speakers with the Speakon cable to the amplifier **(8)**. To comply emission standards stated in chapter 5.1 we advise the usage of the Speakon cable provided by Musikelectronic Geithain GmbH and shipped with the RL-Amplifier. Connect the signal source to the amplifier through the analogue XLR connector **(9)**. the ethernet connector **(10)** is used to integrate the amplifier in an existing computer network.

7.3 Cable connection

The input of the integrated amplifier is electrically balanced. When your signal source also utilizes balanced connectors, please use a cable wired as stated in the table:

	Balanced connector (amplifier)	Balanced connector (signal source)	Unbalanced connector (signal source)
	XLR	XLR	RCA
Earth	Pin 1	Pin 1	Ring
Signal +	Pin 2	Pin 2	Tip
Signal -	Pin 3	Pin 3	Ring

When using a signal source with unbalanced outputs (RCA) you need to balance the connecting cables. This avoids hum and other noise interferences. The table and the following figure show the wiring.

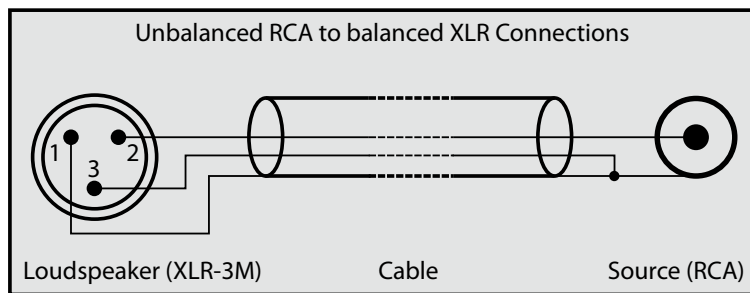

To connect the RL-Amplifier to the corresponding speaker you need a NL8 speakon cable, wired according to the following table:

Power signal (Amplifier)	Power signal (Speaker)
Speakon NL8	Speakon NL8
PIN 1	PIN 1
PIN 2	PIN 2
PIN 3	PIN 3
PIN 4	PIN 4
PIN 5	PIN 5
PIN 6	PIN 6
PIN 7	PIN 7
PIN 8	PIN 8

8 Operation and configuration of the device

The RL-Amplifier can be configured directly at the device or comfortably with a personal computer and ME Geithain DSP Control.

8.1 Desktop software ME Geithain DSP Control

For RL-Amplifier configuration and monitoring is possible via the integrated USB or RJ45 ports with a personal computer (IBM-PC or Macintosh). The according software as well as a user manual is available for download from the Musikelectronic Geithain GmbH website.

8.2 Menu structure

When the RL-Amplifier is switched on the display shows the Home screen with device name and currently loaded preset. Underneath is the Preset menu, used to load and save presets, show the serial number of the DSP module and switch to the LOCKED status. The signal processing parameters of the currently loaded preset are configured in the Channel menu. If there is no input in the lower levels the amplifier returns to the Home screen.

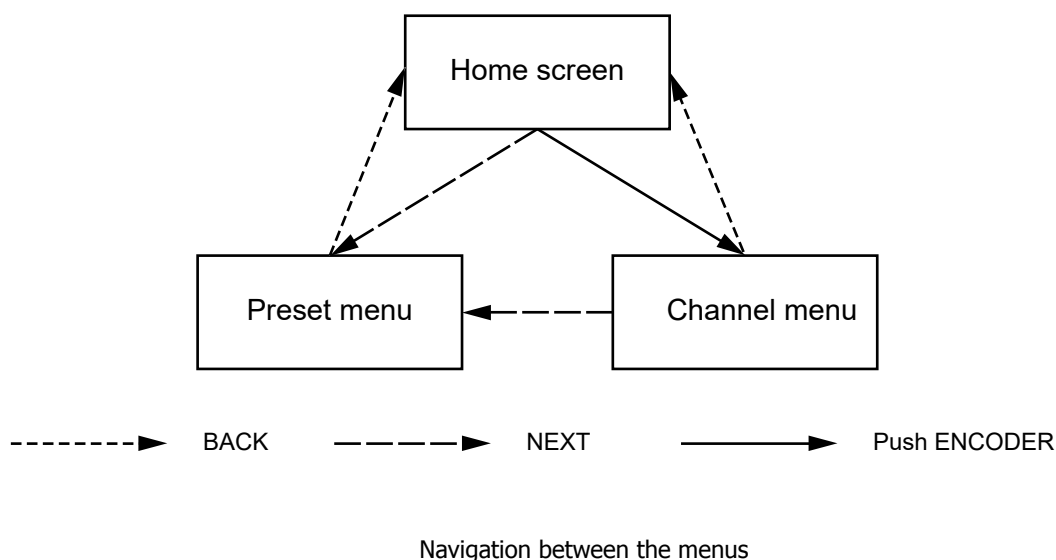

8.3 Home screen

In the first row of the display the Home screen shows the name of the device. In delivery conditions the name complies with the type of the speaker. The second row shows the number of the current preset, then the name of the preset. A "*" at the end of the line indicates that the RL-Amplifier is currently occupied (loading presets, synchronising with the PC software, etc.). Meanwhile controlling the device is not possible.

A "!" at the beginning of the first line indicates unsaved changes in the current configuration.

8.4 Preset menu

The preset menu is at any time accessible by pressing NEXT. The first menu item is LOAD to load a saved preset. Press NEXT again to go on through the preset menu. Turning the rotary encoder changes between presets and pressing it down loads the shown preset. Another menu item asks to confirm the decision by choosing YES and then pressing down the rotary encoder. Choose NO, press NEXT or BACK to abort the action and return to the Home screen. Preset number one in the device holds the factory settings. This preset cannot be overwritten so that it is always possible to restore the factory settings.

Handling the menu item SAVE works in the same way. After choosing a save location, insert a name for the preset. Chapter "8.6 Entering names and passwords", page 18, describes the procedure.

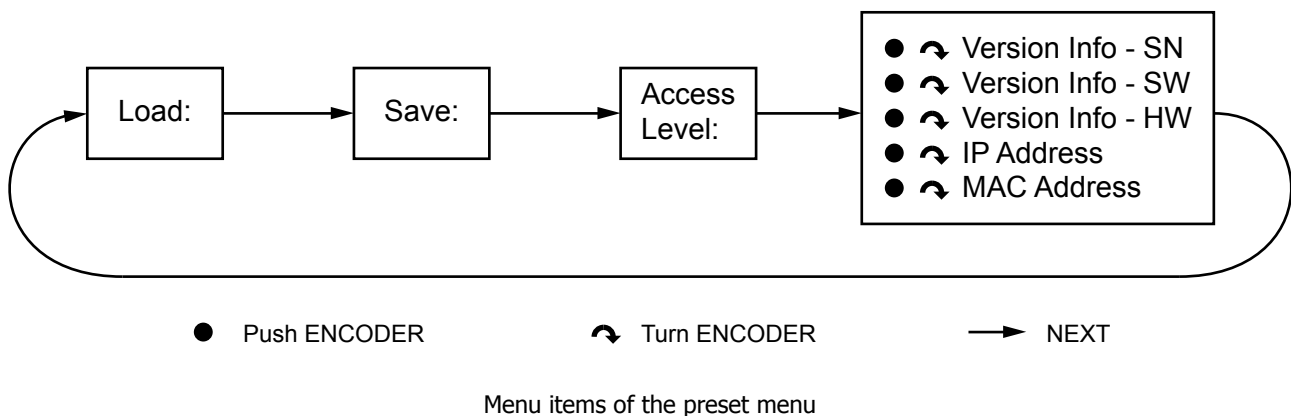

After menu item SAVE follows the access level. To choose the LOCKED status, insert a password according to the user level. In chapter "8.6 Entering names and passwords", page 18, is a description of the procedure.

The last menu item is the information panel. Turn the rotary encoder to browse through items showing the current hardware version, serial number of the DSP module, software version and the IP and MAC address of the device.

8.5 Channel menu

The channel menu is used to browse between the inputs and changing the parameters of the signal processing chain of the according channel. Enter the channel menu by pressing the rotary encoder. The first row shows the current input, an arrow, and the current item. When a left arrow is shown in the first row, the rotary encoder allows choosing an input. Press it down to confirm. When a right arrow is shown, choose a sub-item, shown in the first, similarly to selecting an input. If no arrow is shown between input and sub-item, the parameter is changeable through the rotary encoder. Pressing down the rotary encoder browses through the parameters if more parameters are available to this sub-item. Press NEXT or BACK to confirm any changes. Pressing NEXT redirects to the Preset menu. When pressing BACK, the right arrow reappears to enable choosing between sub-items. All changes remain stored until a new preset is loaded, even when the device is powered off.

The input channels are:

- ◀ In A: analogue (optionally AES)

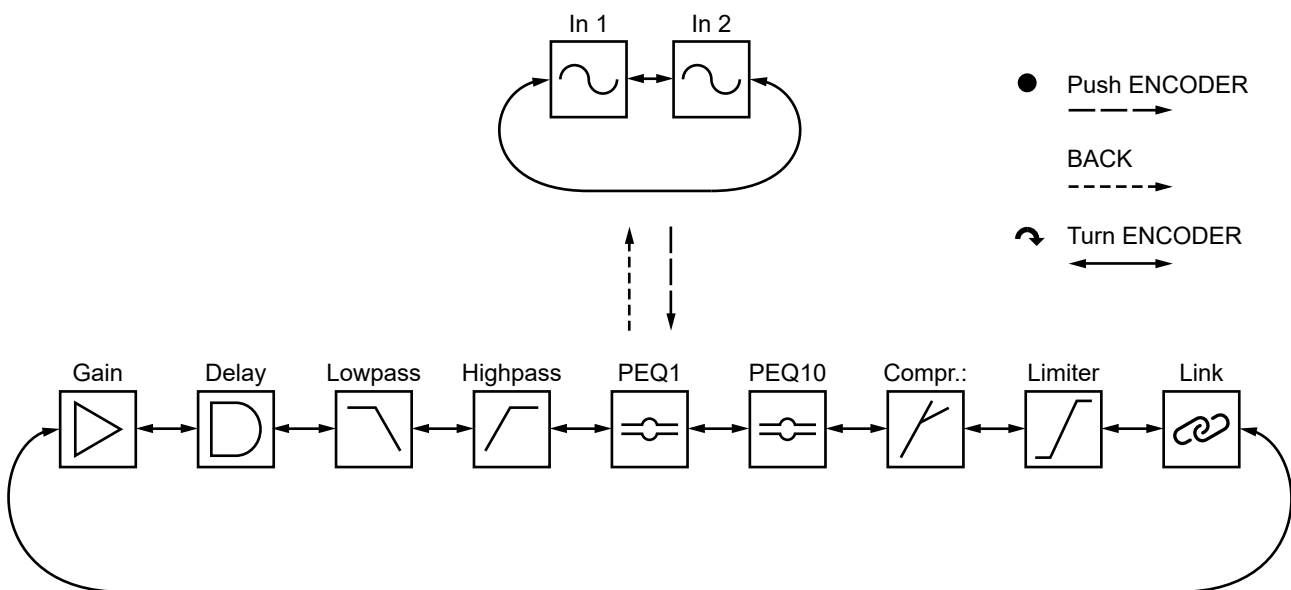

Signal processing chain in a channel

- Gain** Adjust the gain of the channel, e. g. to adjust the balance or volume between analogue and AES signals.
- ◀ Mute: -48 dB... 12 dB
- Source** Choose the signal source in this menu.
- ◀ Analog (standard)
 - ◀ AES Channel A
 - ◀ AES Channel B
 - ◀ AES Mono Sum
 - ◀ AES Stereo
 - ◀ Dante
- Delay:** Delay every input signal, e. g. for compensation of different distances in a 5.1 set-up.
- ◀ 0... 1,000 ms
 - ◀ 0... 1,126 ft
 - ◀ 0... 343.26 m
- LowPass:** Use low-pass filtering on the input signal with different slopes, filter characteristics and variable frequencies.
- ◀ Freq: 50 Hz... 20.000 Hz
 - ◀ Type: BUT 6, 12, 18, 24 dB; BES 6, 12, 18, 24 dB; LR 12, 24 dB
 - ◀ Enabled: Off... On
- HighPass:** Use high-pass filtering on the input signal with the same parameters as the low-pass filter, e. g. filtering the low frequencies of the satellites in a 5.1 set-up.
- ◀ Freq: 20 Hz... 20.000 Hz
 - ◀ Type: BUT 6, 12, 18, 24 dB; BES 6, 12, 18, 24 dB; LR 12, 24 dB
 - ◀ Enabled: Off... On

PEQ1... 10: Parametric filters for adjustments to the room acoustics.

- ◀ Gain: -12 ... 12 dB
- ◀ Freq: 20 Hz ... 20.000 Hz
- ◀ Type: Bell, Notch, High Shelf, Low Shelf, Allpass, Band Pass, High Pass, Low Pass
- ◀ Enabled: Off ... On
- ◀ Q: 0,1 ... 25

Compressor: Compressor for the according channel.

- ◀ Thr.: -48 dBu ... 24 dBu
- ◀ Att.: 1 ... 10.000 ms
- ◀ Hold: 0 ... 10.000 ms
- ◀ Rel.: 1 ... 10.000 ms
- ◀ Ratio: 1,20:1 ... inf:1
- ◀ Gain: -12 dB ... 12 dB

Limiter: Limiter for the input signal.

- ◀ Thr.: -48 dBu ... 24 dBu
- ◀ Rel.: 10 ... 100 dB/s

Link: Use this option to group analogue and digital input signals so that the settings of the left channel are automatically copied to the right channel.

- ◀ Off ... On

8.6 Entering names and passwords

To insert strings like names and passwords through the panel, choose a digit with the rotary encoder and confirm by pressing the rotary encoder down. The cursor will then jump right to the next position. Press BACK and the cursor jumps back to the position to the left.

To confirm a name, press the NEXT button. To access a password protected function it is sufficient to enter the right password.

9 User rights

The device is divided into three user levels with different permissions: LOCKED, USER and ADMINISTRATOR. The levels USER and ADMINISTRATOR are password protected. The LOCKED level prevents changes to the configuration of the device by unauthorized personnel. The device could be started up in the LOCKED mode or USER mode.

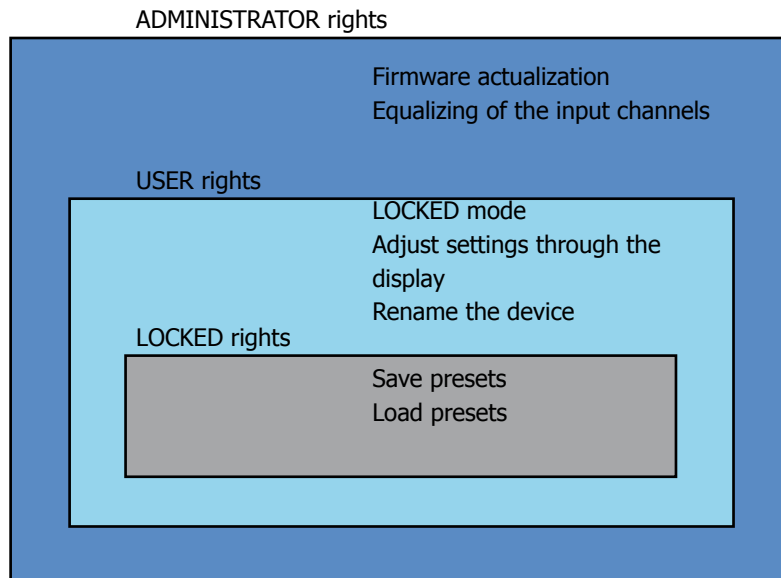

Standard passwords

- ◀ ADMINISTRATOR: TsAmAD7
- ◀ USER: tSAmPUr4

10 Troubleshooting

Error description	Possible causes	Corrective measures
Screen dark	Device in stand-by	Press any key
	Device is switched off	Ensure the device is switched on
No sound	Speakers are not connected correctly	Examine the XLR connections to the speakers
	In-/outputs are muted	Deactivate muting at the device or in the software
	No input signal available	Apply an analogue or digital input signal
Network does not recognize the device	Network cable defect	Exchange the network cable
	No DHCP in the network	Connect the PC directly to the amplifier with a network cable and check the network settings of the device

11 Notes

BDA_RLAMP_17.12.2020_ENV07



musikelectronic geithain gmbh

STUDIO MONITORING - HIGHEND LOUDSPEAKER - SOUND REINFORCEMENT
SYSTEMS SYSTEMS

Nikolaistraße 7
04643 Geithain / Germany

Phone: +49 (0) 34341 3110
Fax: +49 (0) 34341 31144

Email: info@me-geithain.de

www.me-geithain.de